

Analysis of synergism in biochemical networks

Kurtanjek, Želimir

Source / Izvornik: **Food Technology and Biotechnology, 2010, 48, 368 - 375**

Journal article, Published version

Rad u časopisu, Objavljena verzija rada (izdavačev PDF)

Permanent link / Trajna poveznica: <https://urn.nsk.hr/urn:nbn:hr:159:495106>

Rights / Prava: [Attribution-NoDerivatives 4.0 International/Imenovanje-Bez prerada 4.0 međunarodna](#)

Download date / Datum preuzimanja: **2025-03-24**



Repository / Repozitorij:

[Repository of the Faculty of Food Technology and Biotechnology](#)



Analysis of Synergism in Biochemical Networks[#]

Želimir Kurtanjek*

University of Zagreb, Faculty of Food Technology and Biotechnology, Pierottijeva 6,
HR-10000 Zagreb, Croatia

Received: February 8, 2010

Accepted: May 21, 2010

Summary

Probabilistic approach to analysis of synergism in mathematical models of biochemical networks is introduced. It is based on system analysis concept when information on the importance of a parameter of a complex biochemical model is evaluated as part of joint interaction with a complete set of model parameters. For example, this approach accounts for uncertainties in the estimates of enzyme activities and kinetic parameters involved in kinetic modelling of the networks and/or concentration of metabolite or cofactors involved in the interaction of a pathway with perturbations on a cellular level. The parameters are considered as random variables with assumed corresponding probability distribution functions, and total effects of their variability on the network fluxes are evaluated. A numerical measure of synergism of an individual parameter with respect to interaction with model parameters is defined as the difference between the ensemble expected value of conditional variance for the complementary parameters and the variance of conditional expected value of the particular parameter relative to the total parameter ensemble dispersion. In order to demonstrate the concept, the proposed method is applied to two simple cases and to a complex model. The first case is the analysis of synergism between activator and substrate in uni-uni type I mechanism. In the second example, synergism between enzymes involved in a flux through a serial pathway is evaluated. As an example of a complex system, synergism between glycogenolytic flux in a skeletal muscle and involved cellular level cofactors is analyzed.

Key words: synergism, systems analysis, biochemical networks, MathSBML, FAST

Introduction

Advancement of high-throughput experimental technologies and availability of annotated genome, metabolomics and proteomics of numerous industrially important microorganisms leads to *in silico* fundamental research of industrial microbiology. As more data become available, the need for large-scale integrative approaches to biochemistry and biology becomes a prerequisite in development of systems biology. From engineering point of view, possibilities for computer design of synthetic genome and enzymes for development of new technologies are open, for example, such as predicted design of microorganisms for biofuel production. The main obstacles towards this far-reaching goal do not seem to be

on the technical side of genetic engineering synthesis of genome, but rather on biological and system analysis of designed intricate metabolism control on a molecular level. One of the promising fields of system biology which address this problem is mathematical theory of metabolic control analysis, MCA (1,2). At present, MCA analysis is mostly based on steady state (homeostatic constraint) hypothesis and study of one-factor-at-a-time effects of perturbations of each individual enzyme and metabolite concentration on metabolic fluxes and/or individual reaction rates. However, stochastic character of metabolic networks (non-existence of steady state), viewed as the basic property of metabolism responsible for its adaptability and its robustness, needs to be taken into account in system analysis (3,4).

*Corresponding author; Phone ++385 1 460 5294; E-mail: zkurt@pbf.hr

[#]Dedicated to the memory of Prof Vladimir Marić

Methods that could provide biochemically and biologically meaningful information about systemic responses to such large sets of parameters are likely to contribute towards a more integrated understanding of how biochemical processes are coordinated. Such information extracted on the system level will be applicable for future model development and improvement in key aspects, such as better experimental design, reduction of model dimension, increased accuracy of parameter estimation, and determination of key parameters for system design and process control.

Most of the methods available for stochastic mathematical analysis of large scale biological models rely upon extensive computer simulation based on random generators for sampling of stochastic events, *i.e.* Monte Carlo simulation method. Another approach is to use a deterministic model with a random search approach to apply global and constrained optimization methods (genetic algorithm – GA, differential evolution – DE, ant colony optimization – ACO) to investigate optimal capabilities of biochemical pathways (5,6).

However, extraction of single most important factors may lead to misleading conclusions when some factors that have small individual impact are neglected in a model, but they may have significant cooperative effects expressed as high positive or antagonistic synergistic behaviour (7,8).

The aim of this work is to provide a contribution to methodology for a system analysis of a joint interaction, or synergism, between key factors (model parameters) under the assumption that system stochasticity reflects cell environmental fluctuations and/or uncertainties of model parameters.

Methods

A steady state model of a multiple input x single output y (MISO) system with N inputs is considered. Possible inputs are cell substrate influxes, intracellular metabolites or extracellular substrate concentrations, enzyme concentrations, model kinetic parameters, *etc.* Output functions can be molar fluxes through specific pathways, signal transduction, gene transcription rates, intracellular product concentration, effluxes of products, biomass specific or single cell growth rate, and others. For a proposed model, an explicit or implicit output function $y(x)$ is given, which is usually highly dimensional and nonlinear in the case of system biology models. Model inputs, due to cell environmental fluctuations, are seldom known with a precision and may be considered as random variables with assumed probability density functions. In order to determine the systemic effects of the model inputs, effects of simultaneous perturbation of all the inputs Δx on the perturbation of the output function Δy need to be considered by approximation with multi-dimensional r -th order Taylor expansion in the vicinity of a steady state x_0 , given by:

$$y(x_0 + \Delta x) = y(x_0) + \sum_{i=1}^r \frac{1}{i!} (\Delta x \cdot \nabla)^i \cdot y(x) \Big|_{x=x_0} + R_{r+1}(x_0, \Delta x) \quad /1/$$

where R_{r+1} is a truncation function and ∇ is nabla symbol or delta operator. Input perturbations are assumed

with zero expected value, E , statistically independent and with finite variances:

$$E(\Delta x_i) = 0 \quad Cov(\Delta x_i, \Delta x_j) = \delta_{i,j} \quad \sigma^2(\Delta x_i) = \sigma^2(x_i) \quad /2/$$

Based on the local expansion of Eq. 1, a relative first order single factor sensitivity, S_i , can be defined as a ratio between the variance of the output function due to the perturbation of a single i -th input, $\sigma_{y(x_i)}^2$, and the total variance, σ_y^2 , of the output when all perturbations are taken into account (derived from the well-known error propagation formula):

$$S_i = \frac{\sigma_{y(x_i)}^2}{\sigma_y^2} = \frac{\left(\frac{\partial y}{\partial x_i} \right)_{x_0}^2 \cdot \sigma_{x_i}^2}{\sum_{j=1}^n \left(\frac{\partial y}{\partial x_j} \right)_{x_0}^2 \cdot \sigma_{x_j}^2} \quad /3/$$

Localized effects of interaction between the inputs for small perturbations can be approximated by the second order expansion of Eq. 1. The relative measures, here termed as synergism, abbreviated to *Syn*, of the input interactions, are evaluated by the ratio of the variances:

$$Syn_i = \frac{\sigma_{x_i}^2}{\sigma_y^2} \cdot \sum_{\substack{j=1 \\ j \neq i}}^n \left(\frac{\partial^2 y}{\partial x_i \cdot \partial x_j} \right)_{x_0}^2 \cdot \sigma_{x_j}^2 \quad /4/$$

Eq. 4 is obtained from Eq. 3 by considering the numerator as being dependent on all other variables. Due to the fact that here synergism is defined as the ratio of variance, it equally accounts for positive interaction (mutual enhancement) or negative (antagonistic) effects. The factors given by Eq. 4 express the synergism of an individual i -th input with the complementary set of all the inputs. Specifically, when interaction between two individual inputs, x_i and x_j , is considered, a pair-wise $Syn_{i,j}$ synergism coefficient is given by:

$$Syn_{i,j} = \frac{\sigma_{x_i}^2 \cdot \sigma_{x_j}^2}{\sigma_y^2} \cdot \left(\frac{\partial^2 y}{\partial x_i \cdot \partial x_j} \right)_{x_0}^2 \quad /5/$$

However, uncertainties in biological model inputs (parameters) or exogenous perturbations are large, and localized analysis valid for theoretically infinitesimal synergy analysis is not realistic. In order to encompass the whole variability and uncertainty of biological models, a procedure based on ensemble properties is considered. By the extension of the problem from a local property to a property of 'a whole', the original model is extended with the assumptions about the statistical properties of the model inputs. When this information is not experimentally available to a model researcher, it may be considered as part of the model hypothesis. Nevertheless, the model extension to ensemble statistical properties and analysis of their effects on a model performance is an integral part of mathematical model development. It is a basis for rational experimental design by model reduction and focuses on the main single factors and their synergism, and it is also an important tool for model validation.

The method requires evaluation of the first two statistical parameters (expected value and variance) based on the multidimensional probability density function.

Hence, the estimate of the expected value of the model output function $E(y)$ is defined by:

$$E(y(x)) = \int \dots \int \rho(x) \cdot y(x) \cdot dx \quad /6/$$

Assuming that the model inputs x are statistically independent, Eq. 2, the joint probability density function is a product of the individual distribution functions:

$$\rho(x) = \prod_{i=1}^n \rho_i(x_i) \quad /7/$$

Commonly, uniform $\rho_i(x_i) = U_i(x_i)$ or normal $\rho_i(x_i) = N_i(x_i)$ probability distribution functions are assumed. Ensemble variance of the model output function is defined by:

$$\sigma^2(y(x)) = \int \dots \int \rho(x) \cdot (y(x) - E(y(x)))^2 \cdot dx \quad /8/$$

Contribution of a single input, x_i , without synergistic effects, to the ensemble variance of the output is determined as the variance of the conditional expected value of the output for a given value of x_i . Hence, the relative contribution is called a global sensitivity S_i factor and is evaluated by:

$$S_i = \frac{\sigma_{y|x_i}^2}{\sigma_y^2} \quad /9/$$

The difference between the ensemble variance and the sum of global sensitivity coefficients is accounted by the total synergy effects, Syn_T , presented in the model:

$$Syn_T = 1 - \sum_{i=1}^n \frac{\sigma_{y|x_i}^2}{\sigma_y^2} = 1 - \sum_{i=1}^{i=N} S_i \quad /10/$$

Contribution to synergism of a single input x_i is based on the conditional variance $\sigma_{y|x_i}^2$ of the output function y for the complementary set \tilde{x}_i :

$$\tilde{x}_i = \{x_k \in x | x_k \neq x_i\} \quad /11/$$

The ensemble expected value of this variance $E(\sigma_{y|x_i}^2)$ is the total effect of x_i on the model. As a measure of synergism of x_i , the relative difference and the global variance are taken as follows:

$$Syn_i = \frac{E(\sigma_{y|x_i}^2) - \sigma^2(E_{y(x_i)})}{\sigma_y^2} \quad /12/$$

Results and Discussion

Example 1: Activator-substrate, uni-uni type I mechanism

The uni-uni type mechanism (type I when activator binds first) of enzyme kinetics as an example of a simple model with 'built in' synergism is considered (9). The mechanism is schematically presented in Fig. 1.

The reaction rate v is a function of substrate $[S]$ and activator $[A]$ concentrations, and involves three parameters, maximum rate v_{max} , substrate K_S and activator K_A saturation constants given by:

$$v = v_{max} \cdot \frac{[A] \cdot [S]}{K_S \cdot (K_A + [A]) + [A] \cdot [S]} \quad /13/$$

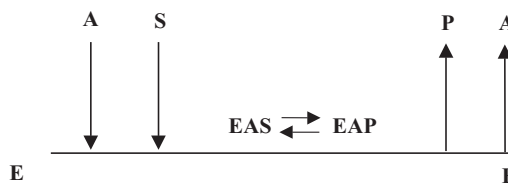

Fig. 1. Schematic presentation of the essential activation in a uni-uni mechanism. E, A, S and P are molecules of enzyme, activator, substrate and product, respectively

Using the appropriate relative reaction rate and concentrations:

$$x_1 = [A]/K_A, \quad x_2 = [S]/K_S \quad \text{and} \quad y = v/v_m \quad /14/$$

the model of the reaction rate becomes dimensionless, enabling a study of effects of concentrations as the only model input factors regardless of the kinetic parameters:

$$y = \frac{x_1 \cdot x_2}{1 + x_1 + x_1 \cdot x_2} \quad /15/$$

Uniform, $U(x)$, probability density functions are assumed as follows:

$$\rho_1(x_1) = U_1(x_1) = \frac{1}{x_{1M} - x_{1m}} \quad /16/$$

$$\rho_2(x_2) = U_2(x_2) = \frac{1}{x_{2M} - x_{2m}}$$

for concentrations in the range from minimal, x_m , and maximal, x_M , values.

Due to the model simplicity, the conditional expected value functions can be determined analytically:

$$E_{y|x_1} = \frac{(x_{1m} - x_{1M}) \cdot x_2 \cdot (1 + x_2) + \log\left(\frac{(1 + x_{1M} + x_{1M} \cdot x_2)}{(1 + x_{1m} + x_{1m} \cdot x_2)}\right)}{(x_{1m} - x_{1M}) \cdot (1 + x_2)^2} \quad /17/$$

$$E_{y|x_2} = \frac{x_1 \cdot (x_{2m} - x_{2M}) + (1 + x_1) \cdot \log\left(\frac{1 + x_1 + x_{2M} \cdot x_1}{1 + x_1 + x_{2m} \cdot x_1}\right)}{x_1 \cdot (x_{2m} - x_{2M})} \quad /18/$$

The ensemble dispersion $\sigma^2(y(x))$ is obtained by the integral:

$$\sigma_y^2 = \frac{1}{(x_{1M} - x_{1m})(x_{2M} - x_{2m})} \int_{x_{1m}}^{x_{1M}} \int_{x_{2m}}^{x_{2M}} \frac{x_1 \cdot x_2}{1 + x_1 \cdot x_2 + x_1} \cdot dx_1 \cdot dx_2 \quad /19/$$

Using Eqs. 9–12 synergistic effects of activator A and substrate molecule S on the reaction velocity, $Syn y_{1,2} = Syn y_{2,1} = E(\sigma_{y|x_1, x_2}^2) / \sigma_y^2$ are calculated. For comparison, the global effects are compared with the local synergy coefficients based on the evaluation of the partial derivatives, Eq. 5, for the average concentrations $\bar{x}_1 = 0.5 \cdot (x_{1m} + x_{1M})$ and $\bar{x}_2 = 0.5 \cdot (x_{2m} + x_{2M})$. The results are depicted in Fig. 2.

The results show that when a narrow concentration range is considered, there is a small difference between local and global synergy coefficients. For the presented cases, at low concentration ranges, below 50 % of the corresponding saturation constants, the synergy effect accounts for about 10–13 % of enzyme activity. When a

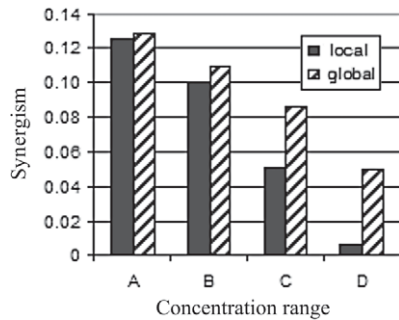

Fig. 2. Local and global synergism between activator A and substrate S calculated at different concentration ranges, within the following minimal (m) and maximal (M) values: A) $x_{1m}=0, x_{1M}=0.25, x_{2m}=0, x_{2M}=0.25$; B) $x_{1m}=0, x_{1M}=0.5, x_{2m}=0, x_{2M}=0.5$; C) $x_{1m}=0, x_{1M}=1, x_{2m}=0, x_{2M}=1$; D) $x_{1m}=0, x_{1M}=2, x_{2m}=0, x_{2M}=2$

broader concentration range is considered, there is a significant difference between globally and locally determined synergy coefficients. For the concentration range (0,1) the local synergy coefficient is about 5 %, but when its global effect is considered it is about 9 %. The most pronounced difference between the local and global effect is for the range (0,2) when the local coefficient is negligible, but the global is on the level of 5 %.

The relative local stochastic synergy coefficient can be compared with the relative deterministic synergy coefficient (8) given by the equation below and depicted in Fig. 3.

$$Syn = \frac{x_1 \cdot x_2}{y(x_1, x_2)} \cdot \frac{\partial^2 y(x_1, x_2)}{\partial x_1 \cdot \partial x_2} \quad /20/$$

The comparison is presented as surfaces of the relative coefficients in the range (0,1) of relative concentration of the activator molecule x_1 and the concentration range (0,2) for substrate molecule x_2 . Range of variability for 10 % of concentrations is applied in the evaluation of stochastic coefficients. The relative values for the two methods differ quantitatively, but more importantly, both of the methods provide very close qualitative trends.

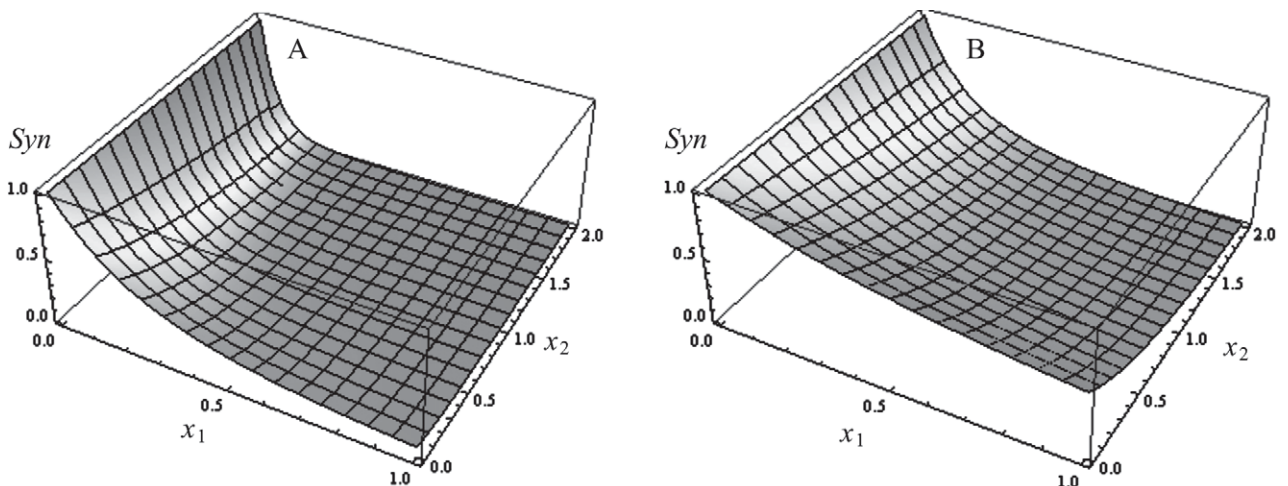

Fig. 3. Comparison of the relative synergy coefficients evaluated by (A) local stochastic and (B) deterministic methods as functions of relative concentrations of activator x_1 and substrate x_2 species

Example 2: Metabolic control analysis (MCA)

Metabolic control analysis, MCA, adopts systemic view on enzyme-metabolite interaction which controls the 'flow' of metabolites through biochemical pathways (1). Analysis of individual enzymes is replaced by a view of a pathway as a 'whole', where collective interaction of enzymes with metabolites is responsible for its biological function. Synergy effects are expected to become important when cooperative effect of metabolites regulates enzymes responsible for a flux in a pathway, and more importantly, when there is a 'cross talk' between pathways on a cellular level. To illustrate the methodology, here is considered a simple unbranched pathway with three enzymes, depicted in Fig. 4.

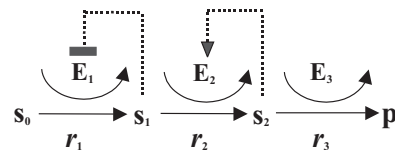

Fig. 4. Schematic presentation of a linear pathway with metabolite enzyme regulation by feedback deactivation (■) and activation (▼)

Simple kinetic models are selected in order to obtain analytical solution for the flux J dependence on the enzyme (concentrations) activities, (v_{1m}, v_{2m}, v_{3m}) . The first enzyme is regulated by the product s_1 in a negative feedback (deactivation), with the following kinetic model:

$$r_1 = v_{1m} \cdot \frac{[s_0]}{K_1 + [s_0] + \frac{[s_1]}{K_{11}}} \quad /21/$$

The second enzyme is regulated by the product s_2 through a positive feedback (activation) with the rate expression:

$$r_2 = v_{2m} \cdot \frac{[s_1]}{K_2 + [s_1]} \left(1 + \frac{[s_2]}{K_{22}} \right) \quad /22/$$

For the reason of simplicity, for the third enzyme the first order kinetics is assumed:

$$r_3 = v_{3m} \cdot [s_2] \quad /23/$$

MCA is analyzed at a steady state when the rates are equal:

$$J(v_{1m}, v_{2m}, v_{3m}) = r_1(v_2) = r_2(v_2) = r_3(v_3) \quad /24/$$

This is a system of equations which can be solved analytically:

$$J(v_{1m}, v_{2m}, v_{3m}) = \frac{v_{1m} \cdot [s_0]}{[s_0] + K_1 \left(1 + \frac{[s_1(v_{1m}, v_{2m}, v_{3m})]}{K_{11}} \right)} \quad /25/$$

where the explicit expression for $[s_1(v_{1m}, v_{2m}, v_{3m})]$ is given in the Appendix, Eq. A1. From biochemical engineering point of view, determination of the 'key' enzyme as a 'bottle neck' responsible for a flux through a pathway is needed. The knowledge of the key enzyme(s) enables rational planning of flux optimization by genetic engineering methods. Standard MCA analysis is performed by determination of the relative sensitivity coefficients, known as the flux control coefficients C_i .

$$C_i = \frac{J(v_1, v_2, v_3)}{v_i} \cdot \frac{\partial J(v_1, v_2, v_3)}{\partial v_i} \Bigg|_S \quad /26/$$

In Eq. 26 the coefficients are evaluated at a steady state, denoted by S . The enzyme with the largest absolute value of the flux control coefficient represents a 'bottle neck', *i.e.* it is responsible for the flux control. However, the standard MCA approach disregards several important aspects such as usual inaccuracy in the estimates of parameter values in enzyme kinetic models, variability of coenzymes regulated on a cell level, and the fundamental stochastic nature of biochemical networks. In this work standard MCA results are compared with the probabilistic analysis of individual enzyme effects and their synergism in flux regulation. Kinetic parameters (given in Appendix, Example 2) are assumed to be determined with negligible errors and treated as constants. Enzyme activities, defined as products of maximum rates and enzyme concentrations, $v_i = v_{im} [E_i]$, are the stochastic part of the model. They are modelled as random variables with uniform probability density functions in the range $(v_i/2, 2 \cdot v_i)$. Individual effect of enzyme activity v_i on flux J is evaluated by:

$$S_i = \frac{\sigma^2 \left(E \left(J(v) | v_i \right) \right)}{\sigma^2 \left(J(v) \right)} \quad /27/$$

The conditional expected values and variances are calculated using multidimensional numerical integration algorithm NIntegrate provided by Wolfram Research *Mathematica* (10). Synergism of the enzymes is similarly calculated according to Eq. 12. Results of the standard MCA and the stochastic analysis are given in Table 1.

The standard MCA reveals that all of the flux control (95 %) is concentrated on the second step, the second enzyme activity. The third enzyme has a negative control coefficient due to the fact that an increase in its

Table 1. Single factor sensitivities (S), synergism effects (Syn), and flux control coefficients C_i of the enzyme activities on flux J

	v_1	v_2	v_3
C_i	0.0941	0.9406	-0.0408
S_i	0.2238	0.6277	0.0017
Syn_i	0.1646	0.1459	0.0014

concentration results in an increased 'draw' of the second metabolite, which up-regulates the entry to the pathway with positive feedback. The sum of the control coefficients adds up to one, since here only an unbranched pathway is considered. Results of the flux control under the assumption of stochastic framework reveal that the regulation is more evenly distributed among enzymes. Single factor control is about 75 % of the control and 25 % accounts for synergism between enzymes. The dominant enzyme is, as previously, the second enzyme, but its relative dominance is greatly reduced (from 10:1 to 3:1). The synergism of the third enzyme is positive, although it has an antagonistic effect, which is not recognized through variance evaluation.

Example 3: Glycogenolysis

Glycogenolysis in a skeletal muscle is selected as an example of a complex model for the analysis of global regulation (11). The model is a space lumped, nonlinear and highly interconnected dynamic system, based on 22 mass balances corresponding to the involved biochemical species, with 16 kinetic rate models, and 91 kinetic parameters. Formally, it is an initial value problem given by a set of deterministic ordinary differential equations. The biochemical network is schematically depicted in Fig. 5.

The model is available in SBML (Systems Biology Markup Language) format from open source BioModels Database (model no. 6623617994) (12). It can be imported by COMplex Pathway Simulator (COPASI) for model read-out, simulation and analysis (13). In order to use the potential of highly sophisticated algorithms available from Wolfram Research *Mathematica* software (10), it is also translated and read by MathSBML software (14). It is an open-source package for work with SBML models in *Mathematica*, which provides facilities for importing SBML models and their conversion to the systems of ordinary differential equations for simulation and plotting in *Mathematica*, and also for the translation of models to other formats. The model is simulated by the use of very efficient and intelligent algorithm NDSolve from *Mathematica* software for numerical integration from the initial conditions to the steady states. The flux is calculated at steady state conditions for a given choice of initial conditions and parameters. The aim is to use computer simulation for inference of effects of cofactors (ATP, ADP, AMP, NADH, NAD⁺) and phosphor (P) on glycogenolysis steady state flux from glycogen to lactate, depicted in Fig. 6. These factors are regulated on the level of global cell metabolism and are assumed to be random variables due to constant perturbations exerted on a cell from the environment. The aim is to use

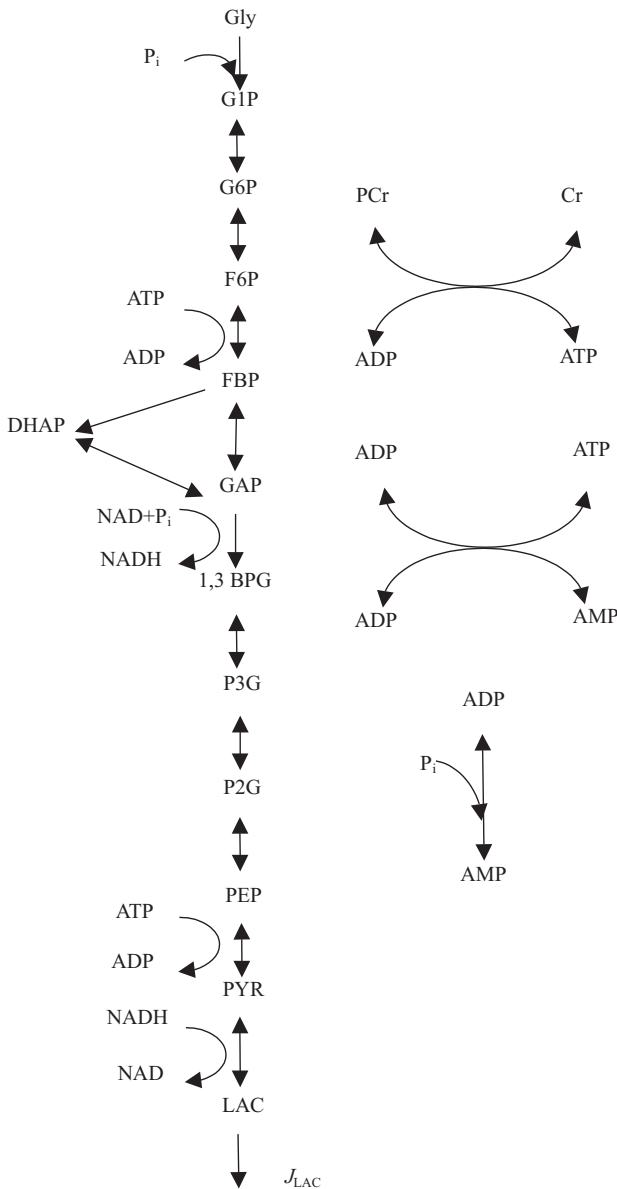

Fig. 5. Schematic presentation of the model of glycogenolysis of a skeletal muscle (11). The complex interaction of metabolite and cofactor with enzymes is not presented for simplicity of the presentation

simulation results in evaluation of global single factor sensitivities and synergism effects of each individual factor. Simulations are performed by scanning the factor space by Lissajou curve with correspondence between each factor and a single frequency, given by Eq. A3 in the Appendix.

Frequencies are selected to ensure unbiased sampling, *i.e.* the samples must be uncorrelated. Contribution of each factor to the total variance of the samples can be solved by the application of Fourier analysis, Eq. A4. This method was proposed by Cukier *et al.* (15) for the analysis of kinetic parameter sensitivities in chemical kinetic models. The method has been extended, known as Fourier amplitude sensitivity test (FAST), and is applicable to global sensitivity analysis of the systems (16,17).

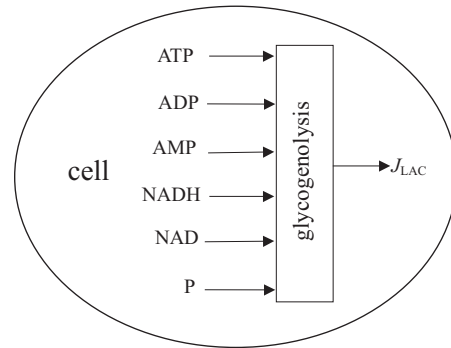

Fig. 6. Schematic presentation of the concept of synergy analysis between the concentrations of species regulated at cell level, interacting cofactors, phosphorus and the glycogenolytic flux from glycogen to lactate J_{LAC}

By the extended method together with global single factor sensitivities (Eq. A5), determination of synergy contributions among factors is enabled (Eq. A6). The extended FAST method is significantly more efficient, in the sense of needed evaluation of model responses, when compared to standard Monte Carlo simulation. For the studied case of glycogenolysis, results presented in Fig. 7 were obtained with 2000 simulations by *Mathematica* NDSolve. Each factor was simulated as a random variable with uniform probability density function in the range of 20 % around their corresponding nominal values. The results are presented in Fig. 7, from which it is obvious that ATP concentration as a single factor exerts more than 95 % of global influence on the steady state lactate flux. The total effect of synergism between the

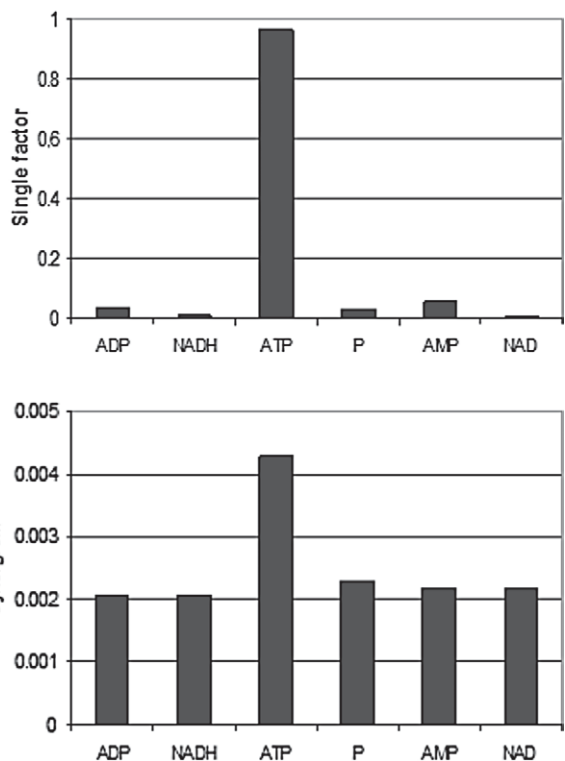

Fig. 7. Global single, S , and synergism coefficients, Syn , of cofactors and phosphorus on the steady state lactate flux, J_{LAC}

factors is very small, less than 2 %. The obtained results for the global effect of ATP on lactate flux are in accordance with the obtained results for its local sensitivity as reported in literature (5,11).

Conclusion

A methodology of evaluation of synergism in biochemical models was presented. The aim was to apply synergy analysis in complex biochemical systems for model development and validation. To reveal the intensity of interactions in high complexity of biochemical systems, the method was based on the analysis of an ensemble or global variance. In order to verify the results of the global synergy analysis, they were compared to the synergy coefficients obtained by the local evaluation.

Two relatively simple models of uni-uni type I enzyme kinetics and flux analysis through an unbranched pathway of three enzymes in a consecutive reactions were considered as test cases. It was shown that the difference between the local synergy coefficients and the variance-based coefficients became very small as the domain of variation was reduced.

However, in the analysis of the metabolic flux control, the local method of flux control coefficients reveals a negative value, which cannot be taken into account by

the variance method. Nevertheless, the disadvantage of the locally determined control coefficients is its overestimation of the control of a single enzyme depending on the choice of substrate and enzyme activities assumed in a steady state local analysis. The results of the analysis based on global variance show a more spread-out control and also reveal significant impact of the collective synergism of all enzymes in a pathway.

As an example of a complex model, a flux control of glycogenolysis in a skeletal muscle depending on cofactors and ATP was considered. Due to complexity of the model, availability of COPASI, MathSBML and Wolfram Research *Mathematica* softwares proved to be indispensable. Especially the efficiency and stability of numerical simulation by NDSolve provided by *Mathematica* enabled efficient application of the FAST method. The obtained results are in agreement with the previously reported values for sensitivities using the local methods which confirm that ATP exerts dominance over the flux.

The emphasis of the proposed methodology on systemic properties rather than on the local ones enables its use on complex biochemical systems where collective behaviour dominates over local or single factor influence. Possible application is in rational design of biochemical networks for specific productions, such as in the development of biofuel technologies.

Appendix

Example 2

$$\begin{aligned}
 A(v_{1m}, v_{2m}, v_{3m}) &= -v_{2m} \cdot v_{3m} \cdot K_1 \cdot K_{11} \cdot K_{21} + \\
 &+ (v_{1m} \cdot v_{3m} \cdot K_{11} \cdot K_{21} - v_{1m} \cdot v_{2m} \cdot K_{11} - v_{2m} \cdot v_{3m} \cdot K_{11} \cdot K_{21}) \cdot s_0 \\
 [s_1(v_{1m}, v_{2m}, v_{3m})] &= \frac{1}{2 \cdot v_{2m} \cdot v_{3m} \cdot K_1 \cdot K_2} \cdot \\
 &\cdot \left(A(v_{1m}, v_{2m}, v_{3m}) + \sqrt{4 \cdot v_{1m} \cdot v_{2m} \cdot v_{3m}^2 \cdot K_1 \cdot K_{11} \cdot K_2 \cdot K_{21}^2 \cdot s_0 + A(v_{1m}, v_{2m}, v_{3m})^2} \right)
 \end{aligned} \tag{A1/}$$

Kinetic parameters

$$\begin{aligned}
 v_1 &= 0.75 \quad v_2 = 0.5 \quad v_3 = 7.5 \\
 K_1 &= 1 \quad K_{11} = 5 \quad K_2 = 0.5 \quad K_{22} = 1.5 \quad s_0 = 10
 \end{aligned} \tag{A2/}$$

Example 3

$$x_i(s) = \frac{1}{2} + \frac{1}{\pi} \cdot \arcsin(\sin(\pi \cdot \omega_i \cdot s + \varphi_i)) \tag{A3/}$$

$$A_w = \frac{1}{2 \cdot \pi} \cdot \int_{-\pi}^{\pi} y(s) \cdot \cos(\omega \cdot s) \cdot ds \quad B_w = \frac{1}{2 \cdot \pi} \cdot \int_{-\pi}^{\pi} y(s) \cdot \sin(\omega \cdot s) \cdot ds \tag{A4/}$$

$$S^2 = 2 \cdot \sum_{\omega}^N (A_{\omega}^2 + B_{\omega}^2) \quad S_i^2 = 2 \cdot \sum_{\omega=1}^M (A_{\omega}^2 + B_{\omega}^2) \quad S_{-i}^2 = 2 \cdot \sum_{\omega=1}^M (A_{\omega}^2 + B_{\omega}^2) \tag{A5/}$$

$$Syn_i = (S^2 - S_i^2 - S_{-i}^2) / S^2 \tag{A6/}$$

References

1. G. Stephanopoulos, A. Aristidou, J. Nielsen: *Metabolic Engineering: Principles and Methodologies*, Academic Press, San Diego, CA, USA (1998).
2. G. Stephanopoulos, *Metabolic engineering: Enabling technology for biofuels production*, *Metabolic Eng.* 10 (2008) 293–294.
3. E.O. Voit, M. Del Signore, *Assessment of effects of experimental imprecision on optimized biochemical systems*, *Bio-tech. Bioeng.* 74 (2001) 443–448.
4. V. Shahrezaei, P.S. Dwain, *The stochastic nature of biochemical networks*, *Curr. Opin. Biotechnol.* 19 (2008) 369–374.
5. S. Sahle, P. Mendes, S. Hoops, U. Kummer, *A new strategy for assessing sensitivities in biochemical models*, *Phil. Trans. R. Soc. A*, 366 (2008) 3619–3631.
6. N.P. Barrera, S. Torres, B. Morales, M. Villalon, *Prediction of synergism on frequency responses in the attojoule range*, *Phys. Chem. Chem. Phys.* 6 (2004) 1806–1814.
7. N.P. Barrera, B. Morales, S. Torres, M. Villalon, *Principles: Mechanisms and modeling of synergism in cellular responses*, *Trends Pharm. Sci.* 26 (2005) 526–532.
8. A. Salvador, *Synergism analysis of biochemical systems. I. Conceptual framework*, *Math. Biosci.* 163 (2000) 105–129.
9. D.L. Purich, R.D. Allison: *Handbook of Biochemical Kinetics*, Academic Press, London, UK (2000).
10. Wolfram Research *Mathematica*, v. 7 (2009) (<http://www.wolfram.com>).
11. M.J. Lambeth, M.J. Kushmerick, *A computational model for glycogenolysis in skeletal muscle*, *Annals Biochem. Eng.* 30 (2002) 808–827.
12. N. Le Novère, B. Bornstein, A. Broicher, M. Courtot, M. Donizelli, H. Dharuri, L. Li, H. Sauro, M. Schilstra, B. Shapiro, J.L. Snoep, M. Hucka, *BioModels Database, A free, centralized database of curated, published, quantitative kinetic models of biochemical and cellular systems*, *Nucleic Acids Res.* 34 (2006) D689–D691.
13. COPASI software, v. 4.5, build 30 (2009) (<http://www.copasi.org/tiki-index.php>).
14. MathSBML software, v. 6 (2009) (<http://sbml.org/Software/MathSBML>).
15. R.I. Cukier, C.M. Fortuin, K.E. Shuler, A.G. Petschek, J.H. Schaibly, *Study of the sensitivity of the coupled reaction systems to uncertainties in rate coefficients. I. Theory*, *J. Chem. Phys.* 53 (1970) 3873–3878.
16. A. Saltelli, M. Ratto, S. Tarantola, F. Campolongo, *Sensitivity analysis of chemical models*, *Chem. Rev.* 105 (2005) 2811–2828.
17. A. Saltelli, K. Chan, E.M. Scott: *Sensitivity Analysis*, John Wiley&Sons, Ltd, Chichester, UK (2000).